

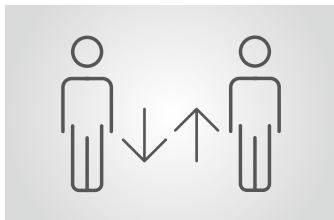

For persons in outdoor areas

MPT double turnstiles are the ideal solution for outdoor access control when two passages are required where space is limited. MPT turnstiles can be precisely adapted to your intended purpose thanks to the drive variants offered: the electric motor-driven MPT 152 turnstile is set in motion by means of an energy-efficient, maintenance-free MHTM™ drive unit – the first choice for representative security for outdoor areas and company grounds. The MPT 53 has an electromechanical locking unit and the rotary movement is generated by users themselves – a popular variant at leisure parks and stadiums. Both drive versions can be controlled

by means of all conventional access control systems and can be operated in both throughflow directions as an option. The purely mechanical MPT 50 turnstile only lets visitors pass in one direction and is thus particularly suitable for unmonitored exits at swimming pools and sports facilities. MPT turnstiles can also be individually adapted to your requirements in other ways: with a variety of material options, interlock variants, additional attachments and expansions for bicycles, wheelchairs and the transport of material.



Two passages in one

MPT double turnstiles are the optimum solution when two separate passages need to be set up in the most limited of spaces.



Innovative drive technology

The MHTM™ drive unit (optional) is maintenance-free, energy-efficient, and has an exceptional soft-start action.

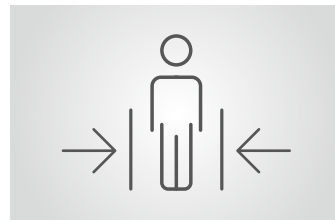

Maximum safety

Low impact forces and sensitive contact detection offer optimum protection for users.

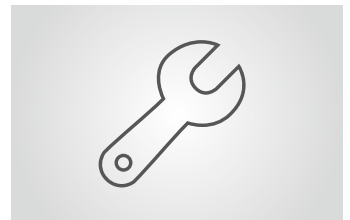

Easy access to components

All the components necessary for operation are accommodated in the main beams, considerably simplifying assembly, commissioning and maintenance.

MPT

Double Turnstile

- > Space-saving double system for two independent passageways
- > Mechanical, electromechanical or motorized designs available
- > Sensitive impact detection for maximum safety
- > Numerous options, e.g. expansion for wheelchair access
- > Meets European safety standards, e.g. EN 13241



Technical data	MPT 152 3-wing	MPT 152 4-wing	MPT 53 3-wing	MPT 53 4-wing	MPT 50 3-wing	MPT 50 4-wing
Number of wings (angle)	3 (120°)	4 (90°)	3 (120°)	4 (90°)	3 (120°)	4 (90°)
Drive technology	MHTM™		electromechanical		mechanical	
Voltage	110 – 240 VAC, 50/60 Hz		110 – 240 VAC, 50/60 Hz		–	
Power consumption	approx. 50 W		approx. 50 W		–	
Duty cycle	100 %		100 %		–	
Enclosure rating	IP 43		IP 43		IP 43	
Dimensions (L x W x H)	2210 x 1318 x 2235 mm	2071 x 1382 x 2235 mm	2210 x 1318 x 2235 mm	2071 x 1382 x 2235 mm	2210 x 1318 x 2235 mm	2071 x 1382 x 2235 mm
Weight	approx. 450 kg	approx. 500 kg	approx. 450 kg	approx. 500 kg	approx. 450 kg	approx. 500 kg
Temperature range	–25 to +55°C		–25 to +55°C		–25 to +55°C	

Options

Material	Galvanized steel, powder-coated steel in standard colors, powder-coated steel in special colors, stainless steel V4A
Reaction to power failure	Free access or auto-locking on power failure
Attachments	Anbausäule, Beleuchtung, Fundamentrahmen, Fundamentbefestigungssatz, Dach
Expansions	Controlled access for bicycles, wheelchairs and the transport of material (MPG 162)

Potential applications

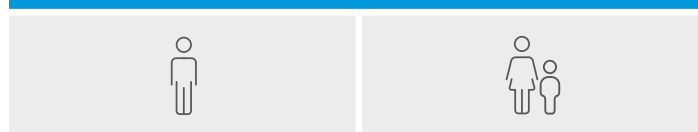

Standard colors

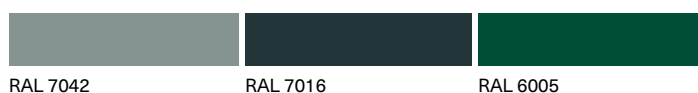

MPT 152/53/50 – 3-wing variants
View from inside

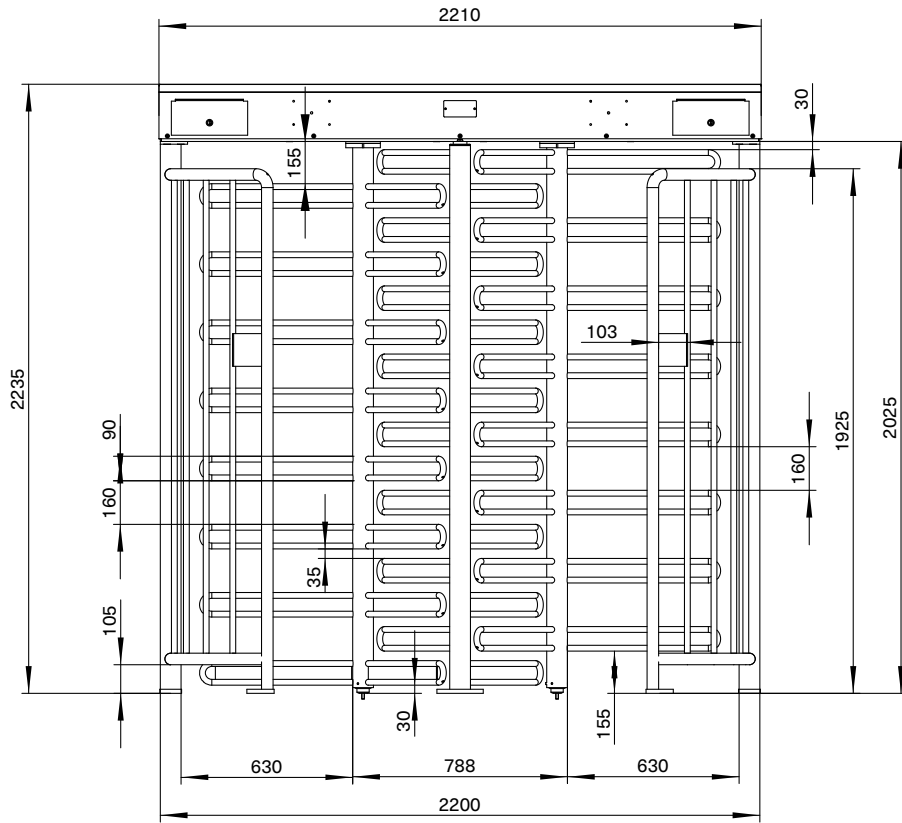

MPT 152/53/50 – 3-wing variants
View from the side

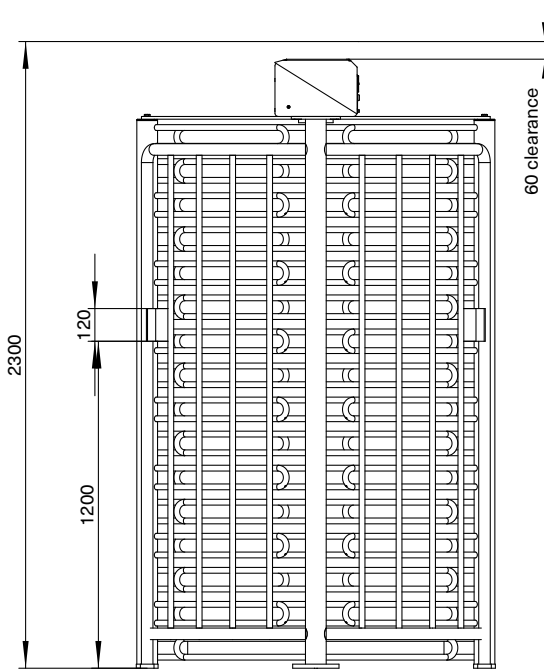

MPT 152/53/50 – 3-wing variants
View from below

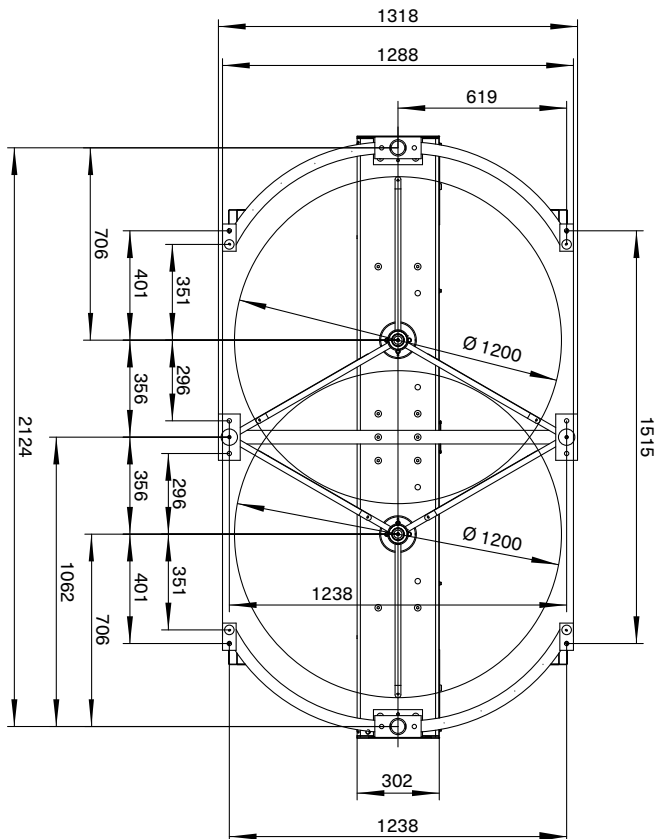

Access to Progress

Magnetic stands for pioneering products – in every way. Our access control systems for vehicles or pedestrians clear the way for thousands of people every day – at car parks, toll gates, stations, airports and in buildings. Our technology is also pioneering, however: with innovative drives, intelligent control systems and well thought-out details it provides maximum safety and longevity. Are you also on the path to Magnetic?

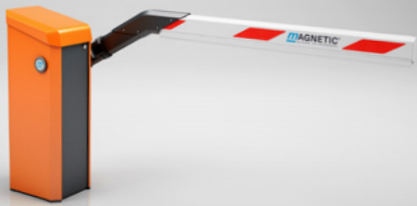

Vehicle barriers

Access barriers
Parking barriers
Toll barriers
Special barriers



Pedestrian gates

Turnstiles
Swing gates
Tripod gates
Retractable gates
Wing gates



Terminals

Cars
Trucks

Germany
MAGNETIC AUTOCONTROL GMBH
Grienmatt 20
79650 Schopfheim
Phone +49 7622 695-5
Fax +49 7622 695-800
E-mail info@magnetic-germany.com

Australia
MAGNETIC AUTOMATION PTY LTD
38 Metrolink Circuit
Campbellfield, VIC 3061
Phone +61 3 9339 2900
E-mail info@magnetic-oz.com

Brazil
MAGNETIC AUTOCONTROL LTDA
Av. Salim Antônio Curiati, 136
04690-050 – São Paulo
Phone +55 11 5660 8500
E-mail info@magnetic-br.com

China
MAGNETIC CONTROL SYSTEMS CO., LTD
No. 3 Building, No. 51
Lane 1159, Kang Qiao (East) Road
Kang Qiao Industrial Zone, Shanghai
Phone +86 21 68182970
E-mail info@magnetic-cn.com

France
FAAC FRANCE
377 Rue Ferdinand Perrier
69808 St Priest Cedex
Phone +33 4 72 21 86 89
E-mail info@magnetic-fr.com

India
MAGNETIC AUTOCONTROL PVT LTD.
PRS Centre
Plot No. 373 to 376, 2nd Floor (West Wing)
1st Cross Street, Nehru Nagar
Old Mahabalipuram Road
Kottivakkam (Opp Rayala Technopark, Perungudi)
Chennai 600041
Phone +91 44 421 23297
E-mail info@magnetic-india.com

Middle East
FAAC MIDDLE EAST FZE
Dubai Silicon Oasis
PO Box 54886
Dubai
United Arab Emirates
Phone +971 4 3724193
E-mail info@magnetic-uae.com

N. and S. America (excl. Brazil)
FAAC INTERNATIONAL, INC
3160 Murell Road
Rockledge, FL 32955
USA
Phone +1 321 635 8585
E-mail info@magnetic-usa.com

Scandinavia
FAAC NORDIC AB
Box 125
284 22 Perstorp
Sweden
Phone +46 435 77 95 03
E-mail info@magnetic-nordic.com

Southeast Asia
MAGNETIC CONTROL SYSTEMS SDN. BHD
No. 17, Jalan Anggerik Mokara 31/54
Taman Perindustrian Kota Kemuning
40460 Shah Alam
Selangor Darul Ehsan
Malaysia
Phone +60 3 5123 0033
E-mail info@magnetic-malaysia.com